

INSTALLATION INSTRUCTION
COMPASS - Outdoor Flush Mount
 FM-W33612/FM-W33616

WAC LIGHTING
 Responsible Lighting®

WARNING

IMPORTANT: NEVER attempt any work without shutting off the electricity.

- Read all instructions before installing.
- System is intended for installation by a qualified electrician in accordance with the National Electrical Code and local regulations.
- Go to the main fuse box, or circuit breaker. Place the main power switch in the "OFF" position and unscrew the fuse(s) or switch "OFF" the circuit breaker switch(es) that control the power to the fixture or room that you are working on.
- Place the wall switch in the "OFF" position.

CAUTION

- All parts must be used as indicated in these instructions. Do not substitute any parts, leave parts out, or use any parts that are worn out or broken. Failure to follow this instruction could invalidate the ETL/CETL listing of this fixture.
- CAUTION When handling the fixture, do not apply pressure to the LEDs. Hold the fixture by the base only.

AVERTISSEMENT

IMPORTANT : Coupez l'électricité avant TOUTE manipulation.

- Lisez toutes les instructions avant d'installer.
- Système est destiné à être installé par un électricien qualifié en conformité avec le code national de l'électricité et les règlements locaux.
- Accédez au panneau central de disjoncteurs ou de fusibles de votre demeure et placez l'interrupteur principal en position d'arrêt (« OFF »).
- Placez l'interrupteur mural en position d'arrêt (« OFF »).

MISE EN GARDE

- Toutes les pièces doivent être utilisées tel qu'il est indiqué dans ces instructions. Ne remplacez pas les pièces, n'en laissez pas de côté et ne les utilisez pas si elles sont usées ou brisées. Le non-respect de ces instructions peut annuler l'homologation ETL/CETL du luminaire. MISE EN GARDE Ors de la manipulation de l'appareil, ne pas appliquer de pression à la LED, tenir l'appareil par la seule base.

ADVERTENCIA









IMPORTANTE: NUNCA intente hacer trabajos sin desconectar el suministro eléctrico.

- Lea y comprenda todas las instrucciones e ilustraciones por completo antes de proceder con el ensamblaje e instalación de esta lámpara.
- Sistema está diseñado para ser instalado por un electricista calificado, de acuerdo con el código eléctrico nacional y las normas locales.
- Diríjase a la caja de fusibles o a la caja del interruptor de circuito principal en su hogar. Coloque el interruptor de alimentación principal en la posición "OFF" (APAGADO).
- Coloque el interruptor de la pared en la posición "OFF" (APAGADO).

PRECAUCIÓN

- Todas las piezas deben usarse como lo indican estas instrucciones. No reemplace las piezas, no omita piezas durante la instalación ni utilice piezas gastadas o rotas. El incumplimiento de esta indicación podría invalidar la calificación ETL/CETL esta lámpara. PRECAUCIÓN Al manipular el aparato, no aplique presión a los LED, mantenga el aparato en la base sólo.

HARDWARE

| A1 | B1 | C1 | D1 | E1 | F1 | G1 | H1 |
|---|---|---|---|---|---|---|---|
|  |  |  |  |  |  |  |  |
| P3 Wire Connector Qty: 3pcs+1Extra 7EAC112201 | Junction Box Screw Qty: 2pcs+1Extra 7MPF0415C2 #8-32x9/16 | Mounting Screw Qty: 1 Extra 7MPF0412S2 5/32"-32x1/2 | Gasket Qty: 1 Extra 7TGD060301CL | Plastic Anchor Qty: 2 pcs 7TDD082401 | Wood Screw Qty: 2pcs 7MPF2204J2 04x22mm Nickel Plating | Allen Wrench Qty: 1 pc 7MPE205001 1/16" | Allen Screw Qty: 1 Extra 7MPF040901NI 5/32"-32x3/8 Nickel Plating |

WAC Lighting

www.waclighting.com
 Phone (800) 526.2588 • Fax (800) 526.2585

Headquarters/Eastern Distribution Center

44 Harbor Park Drive • Port Washington, NY 11050
 Phone (516) 515.5000 • Fax (516) 515.5050

Western Distribution Center

1750 Archibald Ave • Ontario, CA 91761
 Phone (800) 526.2588 • Fax (800) 526.2585



INSTALLATION INSTRUCTION
COMPASS - Outdoor Flush Mount
 FM-W33612/FM-W33616

WAC LIGHTING
 Responsible Lighting®

FIG.1

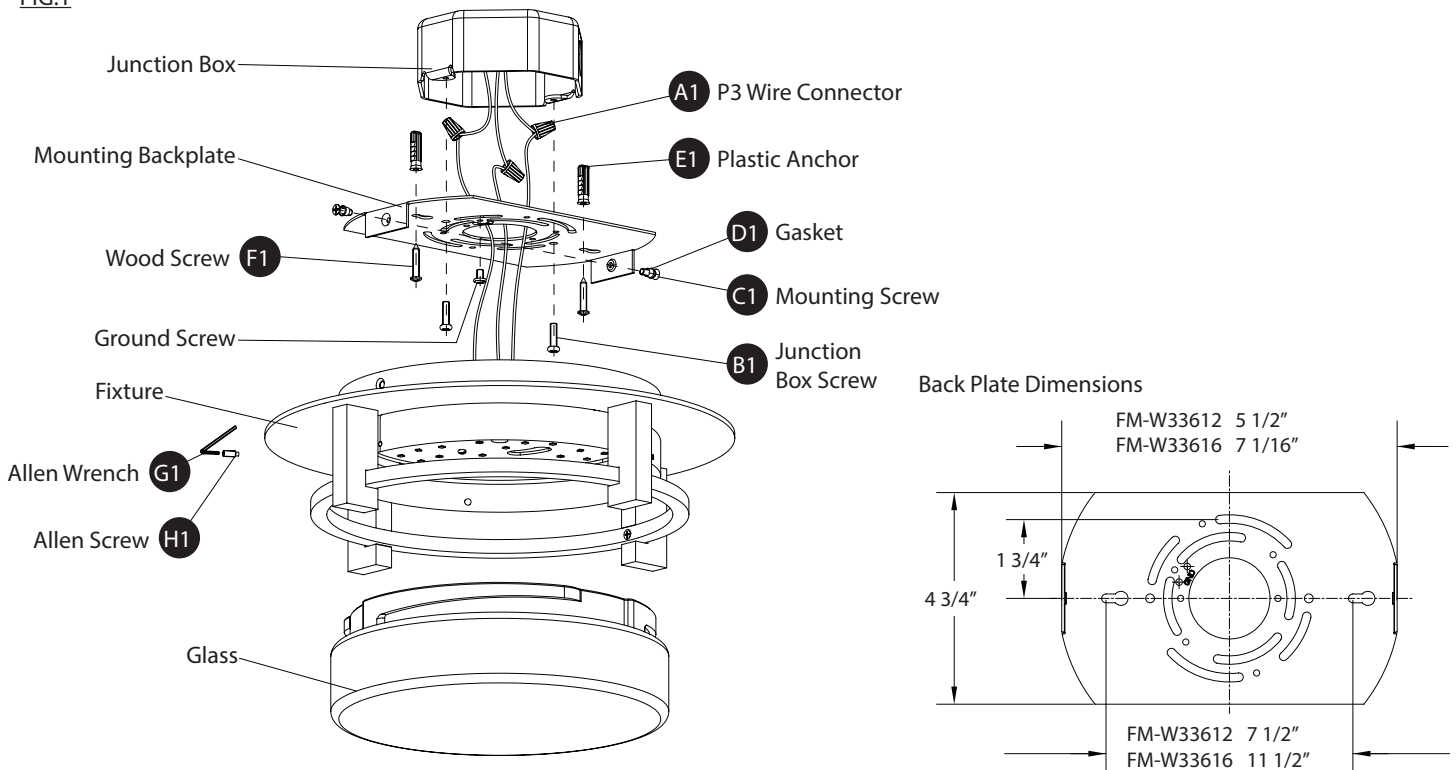

PREPARATION

1. Shut off the power at the circuit breaker and remove existing fixture, including the crossbar.
2. Carefully unpack your new fixture and lay out all the parts on a clear area. Be careful not to lose any small parts necessary for installation.

MOUNTING THE FIXTURE (Fig. 1)

3. Remove the mounting screw (C1) and gasket (D1), and take out the mounting back plate.
4. Drill a hole in the wall aligned with the key hole located in the mounting back plate, insert the plastic anchor (E1).
5. Secure the mounting back plate to the junction box using the junction box screw (B1). Fasten it to the wall using the wood screw (F1). The side of the mounting plate marked "GND" must face out.

CONNECTING THE WIRES (Fig. 2)

6. Connect the fixture wire to junction box wires as shown in Fig. 2, making sure that all wire connectors (A1) are secured. If your outlet box has a green or bare copper ground wire, connect the fixture's ground wire to it. Otherwise, connect the fixture's ground wire directly to the back plate using the green screw provided. After wires are connected, tuck them carefully inside the junction box.

MOUNTING THE FIXTURE (Fig. 1)

7. Secure the fixture to the mounting back plate with mounting screw (C1) and gasket (D1).
8. Twist the glass onto the canopy and tighten it with Allen screw (H1) using Allen wrench (G1).
9. To prevent moisture from entering the outlet box and causing a short, use clear caulking (i.e. indoor/outdoor silicone sealant) to outline the outside of fixture back plate where it meets the wall.

Fig. 2 Wiring

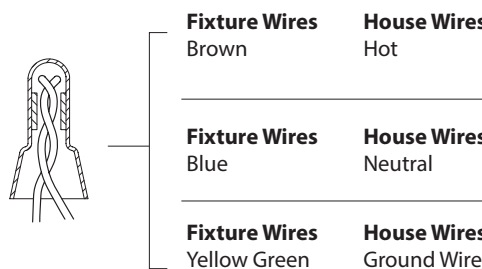
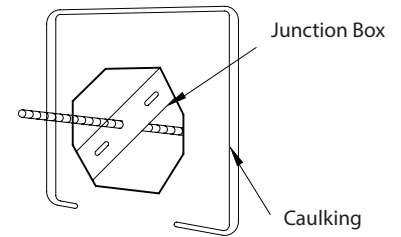

Fig. 3 Sealing



WAC Lighting
 www.waclighting.com
 Phone (800) 526.2588 • Fax (800) 526.2585

Headquarters/Eastern Distribution Center
 44 Harbor Park Drive • Port Washington, NY 11050
 Phone (516) 515.5000 • Fax (516) 515.5050

Western Distribution Center
 1750 Archibald Ave • Ontario, CA 91761
 Phone (800) 526.2588 • Fax (800) 526.2585

