

# INSTALLATION INSTRUCTION

## Soho - dweLED™

WS-6111, WS-6117, WS-6123

# WAC LIGHTING

Responsible Lighting®

### WARNING

IMPORTANT: NEVER attempt any work without shutting off the electricity.

- Read all instructions before installing.
- System is intended for installation by a qualified electrician in accordance with the National Electrical Code and local regulations.
- Go to the main fuse box, or circuit breaker. Place the main power switch in the "OFF" position and unscrew the fuse(s) or switch "OFF" the circuit breaker switch(es) that control the power to the fixture or room that you are working on.
- Place the wall switch in the "OFF" position.

### CAUTION

- All parts must be used as indicated in these instructions. Do not substitute any parts, leave parts out, or use any parts that are worn out or broken. Failure to follow this instruction could invalidate the ETL/CETL listing of this fixture.  
CAUTION When handling the fixture, do not apply pressure to the LEDs. Hold the fixture by the base only.

### AVERTISSEMENT

IMPORTANT : Coupez l'électricité avant TOUTE manipulation.

- Lisez toutes les instructions avant d'installer.
- Système est destiné à être installé par un électricien qualifié en conformité avec le code national de l'électricité et les règlements locaux.
- Accédez au panneau central de disjoncteurs ou de fusibles de votre demeure et placez l'interrupteur principal en position d'arrêt (« OFF »).
- Placez l'interrupteur mural en position d'arrêt (« OFF »).

### MISE EN GARDE

- Toutes les pièces doivent être utilisées tel qu'il est indiqué dans ces instructions. Ne remplacez pas les pièces, n'en laissez pas de côté et ne les utilisez pas si elles sont usées ou brisées. Le non-respect de ces instructions peut annuler l'homologation ETL/CETL du luminaire. MISE EN GARDE Ors de la manipulation de l'appareil, ne pas appliquer de pression à la LED, tenir l'appareil par la seule base.

### ADVERTENCIA

IMPORTANTE: NUNCA intente hacer trabajos sin desconectar el suministro eléctrico.

- Lea y comprenda todas las instrucciones e ilustraciones por completo antes de proceder con el ensamblaje e instalación de esta lámpara.
- Sistema está diseñado para ser instalado por un electricista calificado, de acuerdo con el código eléctrico nacional y las normas locales.
- Diríjase a la caja de fusibles o a la caja del interruptor de circuito principal en su hogar. Coloque el interruptor de alimentación principal en la posición "OFF" (APAGADO).
- Coloque el interruptor de la pared en la posición "OFF" (APAGADO).

### PRECAUCIÓN

- Todas las piezas deben usarse como lo indican estas instrucciones. No reemplace las piezas, no omita piezas durante la instalación ni utilice piezas gastadas o rotas. El incumplimiento de esta indicación podría invalidar la calificación ETL/CETL esta lámpara. PRECAUCIÓN Al manipular el aparato, no aplique presión a los LED, mantenga el aparato en la base sólo.

### HARDWARE

B1



P2 Ground Wire Connector  
Qty: 2pc  
P1  
7EAC140901

D1



P3 Electrical Wire Connector  
Qty: 3pc  
P3  
7EAC112201

E1



Plastic Anchor  
Qty: 2pc  
7TDD082401

F1



Spacer  
Qty: 2pc  
5/32"-32x1/4  
Brass

G1



Junction Box Screw  
Qty: 2pc + 1 Extra  
7MPF0415C2  
#8-32x5/8  
SS

J1



Wall Mounting Screw  
Qty: 2pc + 1 Extra  
04x22  
Nickel Plating

K1



Mounting Screw  
Qty: 2pc + 1 Extra  
5/32"-32x5/16  
7MPF0408S1  
Nickel Plating

M1



Mounting Screw  
Qty: 4pc + 1 Extra  
7MPF0306C4  
1/8"-40x3/16  
Nickel Plating

Z1



Junction Box Screw  
Qty: 2pc  
7MPF0415C2  
#8-32x5/8  
SS

wacighting.com

Phone (800) 526.2588  
Fax (800) 526.2585

Headquarters/Eastern Distribution Center

44 Harbor Park Drive  
Port Washington, NY 11050

Central Distribution Center

1600 Distribution Ct  
Lithia Springs, GA 30122

Western Distribution Center

1750 Archibald Avenue  
Ontario, CA 91760



# INSTALLATION INSTRUCTION

## Soho - dweLED™

WS-6111, WS-6117, WS-6123

# WAC LIGHTING

Responsible Lighting®

### PREPARATION

- Shut off the power at the circuit breaker and remove existing fixture, including the mounting hardware.
- Carefully unpack your new fixture and lay out all the parts on a clear area. Be careful not to lose any small parts necessary for installation.

### CONNECTING THE WIRES (transformer to outlet)

1. Remove the mounting screws (K1) from the fixture. **Fig.2**
2. Connect the transformer (C1) input wires to supply wire as shown in **Fig. 1** and **Fig.2**, making sure that all wire connectors (B1) are secured. After wires are connected, tuck them carefully inside the switch box or junction box. If your outlet box has a green or bare copper ground wire, connect the fixture's ground wire to it. Otherwise, connect the fixture's ground wire directly to the mounting plate (I1) using the green screw provided.

**\* Requires Transformer to be recessed within the junction box**

### MOUNTING THE FIXTURE - Switch box (fig.2)

3. Drill holes in the wall aligned with the key-hole location in the mounting plate (I1), Insert the mounting anchors (E1).
4. Secure the mounting plate (I1) to the switch box (A1) using screws (G1). The side of the mounting plate marked "GND" must face out.
5. Fasten the wood screws (J1) into the mounting anchors (E1). Tighten the mounting plate (I1) to the wall.

### MOUNTING THE FIXTURE - Junction box (fig.3)

6. Drill holes in the wall aligned with the key-hole location in the mounting plate (I1), Insert the mounting anchors (E1).
7. Secure the mounting ring (O1) to the junction box (N1) using screws (G1). Make sure the two holes (spacing 2-3/4") are horizontal as shown in **Fig. 2**. Thread the spacers (F1) into the mounting plate (I1) from back.
8. Place the mounting plate (I1) and the conversion plate (P1) onto the mounting ring (O1). Align the two holes on the mounting plate with the slots on conversion plate (P1) and the holes on the mounting ring (O1), fasten with screws (Z1).

### CONNECTING THE WIRES (fixture to transformer)

9. Connect the transformer output wires to fixture wires as shown in **Fig. 1**, **Fig. 2**, making sure that wire connectors (D1) are secured.
10. Slide the glass onto fixture. Secure end caps (L1) to fixture with screws (M1).
11. Place the fixture over the mounting plate (I1) and secure with screws (K1).

**Fig.1 Wiring**

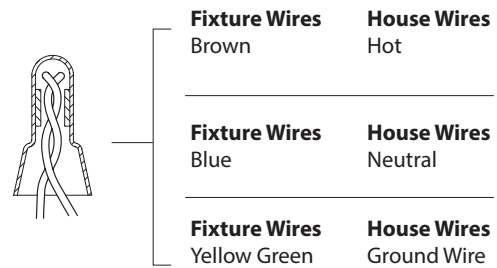

**Fig.2 Mounting (switch box)**

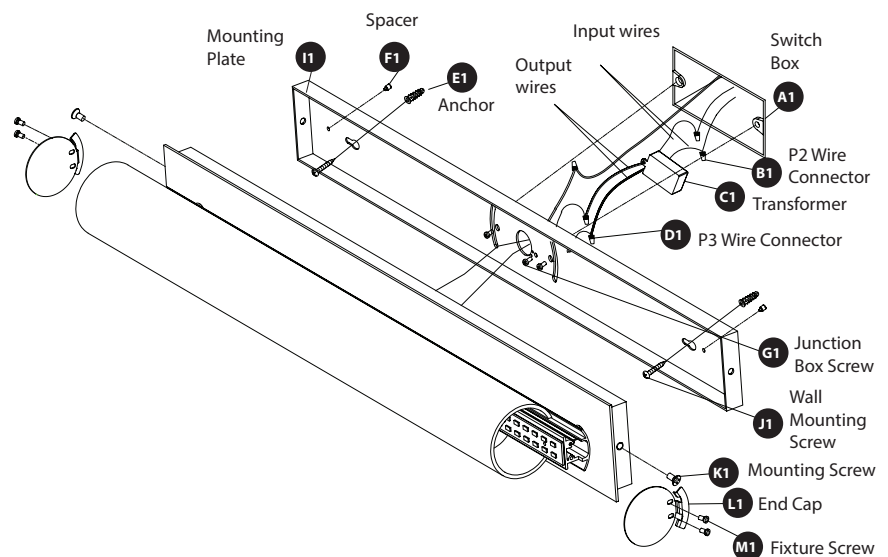

**Fig.3 Mounting (junction box)**

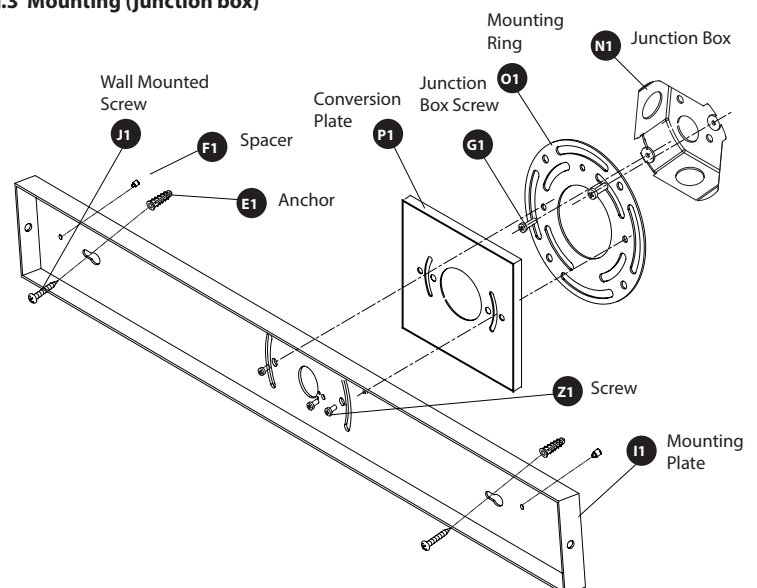

wacighting.com  
Phone (800) 526.2588  
Fax (800) 526.2585

Headquarters/Eastern Distribution Center  
44 Harbor Park Drive  
Port Washington, NY 11050

Central Distribution Center  
1600 Distribution Ct  
Lithia Springs, GA 30122

Western Distribution Center  
1750 Archibald Avenue  
Ontario, CA 91760



**INSTALLATION INSTRUCTION**  
**Soho - dweLED™**  
 WS-6111F, WS-6117F, WS-6123F

**WAC LIGHTING**  
 Responsible Lighting®

**WARNING**

IMPORTANT: NEVER attempt any work without shutting off the electricity.

- Read all instructions before installing.
- System is intended for installation by a qualified electrician in accordance with the National Electrical Code and local regulations.
- Go to the main fuse box, or circuit breaker. Place the main power switch in the "OFF" position and unscrew the fuse(s) or switch "OFF" the circuit breaker switch(es) that control the power to the fixture or room that you are working on.
- Place the wall switch in the "OFF" position.

**CAUTION**

- All parts must be used as indicated in these instructions. Do not substitute any parts, leave parts out, or use any parts that are worn out or broken. Failure to follow this instruction could invalidate the ETL/CETL listing of this fixture.
- CAUTION When handling the fixture, do not apply pressure to the LEDs. Hold the fixture by the base only.

**AVERTISSEMENT**

IMPORTANT : Coupez l'électricité avant TOUTE manipulation.

- Lisez toutes les instructions avant d'installer.
- Système est destiné à être installé par un électricien qualifié en conformité avec le code national de l'électricité et les règlements locaux.
- Accédez au panneau central de disjoncteurs ou de fusibles de votre demeure et placez l'interrupteur principal en position d'arrêt (« OFF »).
- Placez l'interrupteur mural en position d'arrêt (« OFF »).

**MISE EN GARDE**

- Toutes les pièces doivent être utilisées tel qu'il est indiqué dans ces instructions. Ne remplacez pas les pièces, n'en laissez pas de côté et ne les utilisez pas si elles sont usées ou brisées. Le non-respect de ces instructions peut annuler l'homologation ETL/CETL du luminaire. MISE EN GARDE Ors de la manipulation de l'appareil, ne pas appliquer de pression à la LED, tenir l'appareil par la seule base.

**ADVERTENCIA**



















IMPORTANTE: NUNCA intente hacer trabajos sin desconectar el suministro eléctrico.

- Lea y comprenda todas las instrucciones e ilustraciones por completo antes de proceder con el ensamblaje e instalación de esta lámpara.
- Sistema está diseñado para ser instalado por un electricista calificado, de acuerdo con el código eléctrico nacional y las normas locales.
- Diríjase a la caja de fusibles o a la caja del interruptor de circuito principal en su hogar. Coloque el interruptor de alimentación principal en la posición "OFF" (APAGADO).
- Coloque el interruptor de la pared en la posición "OFF" (APAGADO).

**PRECAUCIÓN**

- Todas las piezas deben usarse como lo indican estas instrucciones. No reemplace las piezas, no omita piezas durante la instalación ni utilice piezas gastadas o rotas. El incumplimiento de esta indicación podría invalidar la calificación ETL/CETL esta lámpara. PRECAUCIÓN Al manipular el aparato, no aplique presión a los LED, mantenga el aparato en la base sólo.

**HARDWARE**

								
								
P2 Ground Wire Connector Qty: 2pc P1 7EAC140901	P3 Electrical Wire Connector Qty: 3pc P3 7EAC112201	Plastic Anchor Qty: 2pc + 7TDD082401	Spacer Qty: 2pc 5/32"-32x1/4 Brass	Junction Box Screw Qty: 2pc + 1 Extra 7MPF0415C2 #8-32x5/8 SS	Wall Mounting Screw Qty: 2pc + 1 Extra 04x22 Nickel Plating	Mounting Screw Qty: 2pc + 1 Extra 5/32"-32x5/16 7MPF0408S1 Nickel Plating	Mounting Screw Qty: 4pc + 1 Extra 7MPF0306C4 1/8"-40x3/16 Nickel Plating	Junction Box Screw Qty: 2pc 7MPF0415C2 #8-32x5/8 SS

**WAC Lighting**  
 www.waclighting.com  
 Phone (800) 526.2588 • Fax (800) 526.2585

**Headquarters/Eastern Distribution Center**  
 44 Harbor Park Drive • Port Washington, NY 11050  
 Phone (516) 515.5000 • Fax (516) 515.5050

**Western Distribution Center**  
 1750 Archibald Ave • Ontario, CA 91761  
 Phone (800) 526.2588 • Fax (800) 526.2585



# INSTALLATION INSTRUCTION

## Soho - dweLED™

### WS-6111F, WS-6117F, WS-6123F

#### PREPARATION

- Shut off the power at the circuit breaker and remove existing fixture, including the mounting hardware.
- Carefully unpack your new fixture and lay out all the parts on a clear area. Be careful not to lose any small parts necessary for installation.

#### CONNECTING THE WIRES (transformer to outlet)

1. Remove the mounting screws (K1) from the fixture. **Fig.2**
2. Connect the transformer (C1) input wires to supply wire as shown in **Fig.1** and **Fig.2**, making sure that all wire connectors (B1) are secured. After wires are connected, tuck them carefully inside the switch box or junction box. If your outlet box has a green or bare copper ground wire, connect the fixture's ground wire to it. Otherwise, connect the fixture's ground wire directly to the mounting plate (I1) using the green screw provided.

\* Requires Transformer to be recessed within the junction box

#### MOUNTING THE FIXTURE - Switch box (fig.2)

3. Drill holes in the wall aligned with the key-hole location in the mounting plate (I1), Insert the mounting anchors (E1).
4. Secure the mounting plate (I1) to the switch box (A1) using screws (G1). The side of the mounting plate marked "GND" must face out.
5. Fasten the wood screws (J1) into the mounting anchors (E1). Tighten the mounting plate (I1) to the wall.

#### MOUNTING THE FIXTURE - Junction box (fig.3)

6. Drill holes in the wall aligned with the key-hole location in the mounting plate (I1), Insert the mounting anchors (E1).
7. Secure the mounting ring (O1) to the junction box (N1) using screws (G1). Make sure the two holes (spacing 2-3/4") are horizontal as shown in **Fig.2**. Thread the spacers (F1) into the mounting plate (I1) from back.
8. Place the mounting plate (I1) and the conversion plate (P1) onto the mounting ring (O1). Align the two holes on the mounting plate with the slots on conversion plate (P1) and the holes on the mounting ring (O1), fasten with screws (Z1).

#### CONNECTING THE WIRES (fixture to transformer)

9. Connect the transformer output wires to fixture wires as shown in **Fig.1**, **Fig.2**, making sure that wire connectors (D1) are secured.
10. Slide the glass onto fixture. Secure end caps (L1) to fixture with screws (M1).
11. Place the fixture over the mounting plate (I1) and secure with screws (K1).

**Fig.1 Wiring**

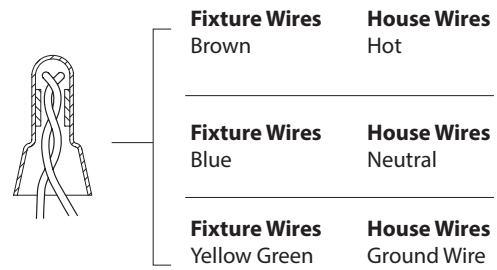

**Fig.2 Mounting (switch box)**

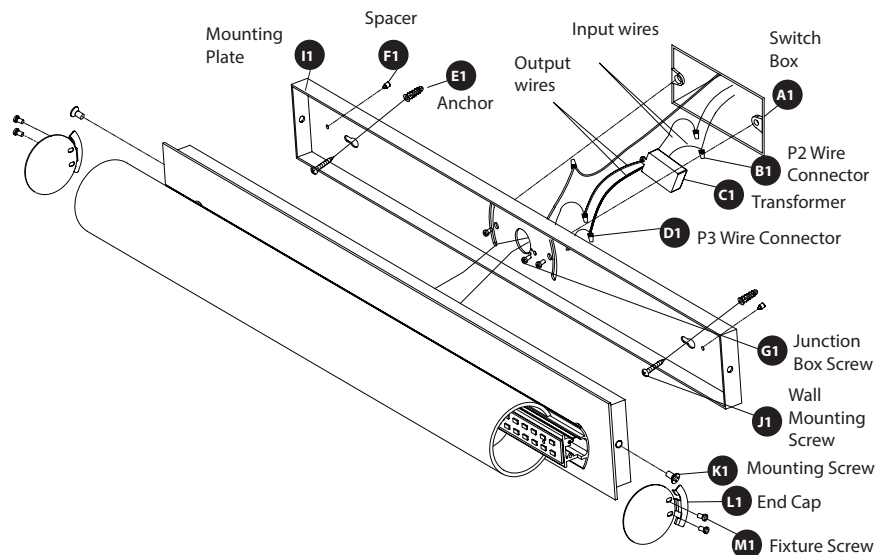

**Fig.3 Mounting (junction box)**

