

CATALOG NUMBER	TYPE
PROJECT	

DECORATIVE WALL SCONCE

MODEL WS52-G518DIC

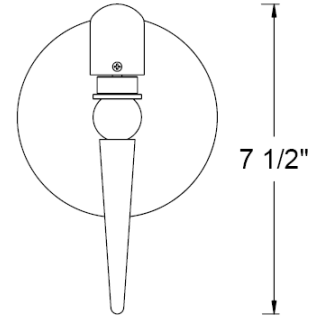
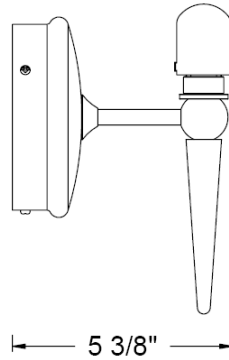
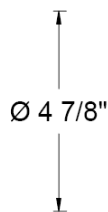

Ordering Matrix

Model Number	Shade	Sconce Finishes	
<input type="text"/>	<input type="text"/>	<input type="text"/>	
WS52	G518DIC	BN	CH

Ordering Example (*model number-shade/ sconce finishes*): WS52-G518DIC/BN

Product Details

Description: Low voltage wall sconce with round finished metal front fascia. The sconce is made of brass, with a plated Chrome or Brushed Nickel finish and a ceramic bi pin socket with screw-on etched bulb shield. Mounting canopy includes an integral electronic transformer..

Mounting: Surface mounted. Installs to a standard 4" junction box.

Lamping 12V 50w halogen bi-pin included.

Transformer: Integral Electronic Low Voltage Transformer. 120v/60hz input.

Sconce Finish: CH = Chrome
BN = Brushed Nickel

Shade: Eden – G518DIC
Spectacular, elegant dichroic glass pendants are diamonds in the rough.

Listing: UL & CUL Listed.

Specification Features

- Dimmable with low voltage electronic dimmers.
- The screw-on bulb shield retains the glass shade and protects the lamp from dust and fingerprints.
- The wall sconce is available in multiple standard glass shade styles and multiple color options
- WAC electronic low voltage transformer includes auto reset, short and overload protection features. Transformer Soft Start delayed start feature extends lamp life by limiting abrupt inrush current to the lamp.
- 5 year WAC Lighting product warranty.

CATALOG NUMBER	TYPE
PROJECT	

LOW VOLTAGE DECORATIVE WALL SCONCE

MODEL WS52-G518DIC

<p>G512 – □ □</p> <p>Finishes: AM – Amber BL – Blue RD – Red WT – White GR – Green</p> <p>2 5/8" x \varnothing 5 1/4"</p>		<p>G515 – □ □</p> <p>Finishes: BW – Blue/White MF – Milliefiore AM – Amber</p> <p>5 1/2" x \varnothing 4 3/4"</p>	
<p>G518 – □ □</p> <p>Finishes: DIC – Dichroic</p> <p>2 7/8" x \varnothing 5 1/4"</p>		<p>G520 – □ □</p> <p>Finishes: OE – Opal Etched</p> <p>2 7/8" x \varnothing 5 1/2"</p>	
<p>G521 – □ □</p> <p>Finishes: OE – Opal Etched</p> <p>2 5/8" x \varnothing 5 1/2"</p>		<p>G524 – □ □</p> <p>Finishes: AM – Amber LB – Light Blue TQ – Turquoise WT – White</p> <p>8 1/4" x \varnothing 6 1/8"</p>	
<p>G530 – □ □</p> <p>Finishes: GR – Green MC – Multicolor</p> <p>5 3/4" x \varnothing 4 1/8"</p>		<p>G540 – □ □</p> <p>Finishes: AM – Amber</p> <p>5 3/4" x \varnothing 4 1/8"</p>	
<p>G545 – □ □</p> <p>Finishes: DIC – Dichroic</p> <p>2 7/8" x \varnothing 4 7/8"</p>		<p>G546 – □ □</p> <p>Finishes: DIC – Dichroic</p> <p>3 7/8" x \varnothing 4 1/3"</p>	
<p>G557 – □ □</p> <p>Finishes: WT – White</p> <p>4" x \varnothing 4 3/5"</p>			

CATALOG NUMBER	TYPE
PROJECT	

DECORATIVE WALL SCONCE

MODEL WS56-G518DIC / WS55-G518DIC

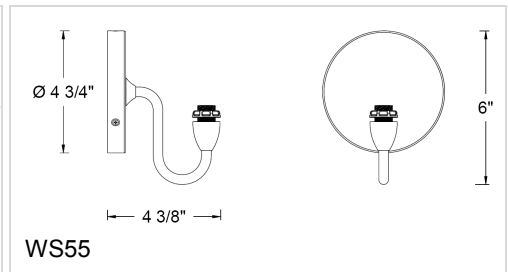
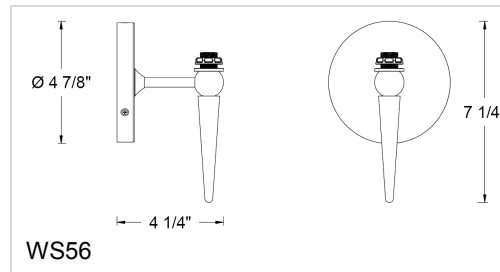

Ordering Matrix

Model Number	Shade	Sconce Finishes	
WS55 WS56	G518DIC	BN	CH

Ordering Example (*model number – shade / sconce finishes*): **WS56-G518DIC/CH**

Product Details

Description: Line voltage wall sconce with round finished metal front fascia. The sconce is made of brass, with plated Chrome or Brushed Nickel finish.

Mounting: Surface mounted. Installs to a standard 4" junction box. Shade mounts to the sconce arm and is secured with threaded locking nut.

Lamping Use with candelabra style incandescent lamp. 120V 60watt max. One 60w lamp included with canopy.

Sconce Finish: CH = Chrome
BN = Brushed Nickel

Shade: Eden – G518DIC
Spectacular, elegant dichroic glass pendants are diamonds in the rough.

Listing: UL & CUL Listed.

Specification Features









- A complete wall sconce consists of the wall canopy and a shade.
- Center mounted vertical lamp configuration allows illumination of the whole glass shade.
- The wall sconce is available in multiple standard glass shade styles and multiple color options
- Use standard incandescent or electronic low voltage dimmer as required.
- 5 year WAC Lighting product warranty.

WAC Lighting reserves the right to modify the design of our products as part of the company's continuous improvement program.

CATALOG NUMBER	TYPE
PROJECT	

LINE VOLTAGE WALL SCONCE

MODEL WS56-G518DIC / WS55-G518DIC

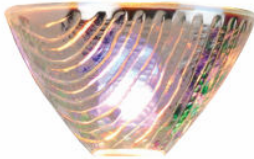
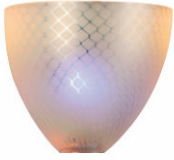
<p>G512 – □ □</p> <p>Finishes: AM – Amber BL – Blue RD – Red WT – White GR – Green</p> <p>2 5/8" x \varnothing 5 1/4"</p>		<p>G515 – □ □</p> <p>Finishes: BW – Blue/White MF – Milliefiore AM – Amber</p> <p>5 7/8" x \varnothing 4"</p>	
<p>G518 – □ □</p> <p>Finishes: DIC – Dichroic</p> <p>2 7/8" x \varnothing 5 1/4"</p>		<p>G520 – □ □</p> <p>Finishes: OE – Opal Etched</p> <p>2 7/8" x \varnothing 5 1/2"</p>	
<p>G521 – □ □</p> <p>Finishes: OE – Opal Etched</p> <p>2 5/8" x \varnothing 5 1/2"</p>		<p>G524 – □ □</p> <p>Finishes: AM – Amber LB – Light Blue TQ – Turquoise WT – White</p> <p>5 1/2" x \varnothing 4 1/2"</p>	
<p>G530 – □ □</p> <p>Finishes: GR – Green MC – Multicolor</p> <p>5 3/4" x \varnothing 4 1/8"</p>		<p>G540 – □ □</p> <p>Finishes: AM – Amber</p> <p>5 3/4" x \varnothing 4 1/8"</p>	
<p>G545 – □ □</p> <p>Finishes: DIC – Dichroic</p> <p>2 7/8" x \varnothing 4 7/8"</p>		<p>G546 – □ □</p> <p>Finishes: DIC – Dichroic</p> <p>3 7/8" x \varnothing 4 1/3"</p>	
<p>G557 – □ □</p> <p>Finishes: WT – White</p> <p>4" x \varnothing 4 3/5"</p>	